

Special Ed

THANKSGIVING IS...

LITERACY UNIT



Special Needs for Special Kids

ALSO INCLUDES GOOGLE SLIDES



These literacy units are something I created and started using in my classroom. I had students with significant challenges and most were **non-readers**. This is a great way to expose all students to some great books.

Table of Contents

Worksheet pages	Activity
4-5	Story Board
6-9	Circle map on Thanksgiving
10-14	Thanksgiving Timeline
15	November calendar
16-18	Sorting things related to Thanksgiving
19-21	Writing prompt Thanksgiving is
22-23	Terms of Use

In a separate file:

- Directions and links to digital activities
- Activities in black and white

This unit has 5 activities to go with this book to last a full week of instruction.

This unit comes with a storyboard.

Storyboards are great for ALL students to assist with participation and engagement in group discussions.

Tips on how to use in the unit!!

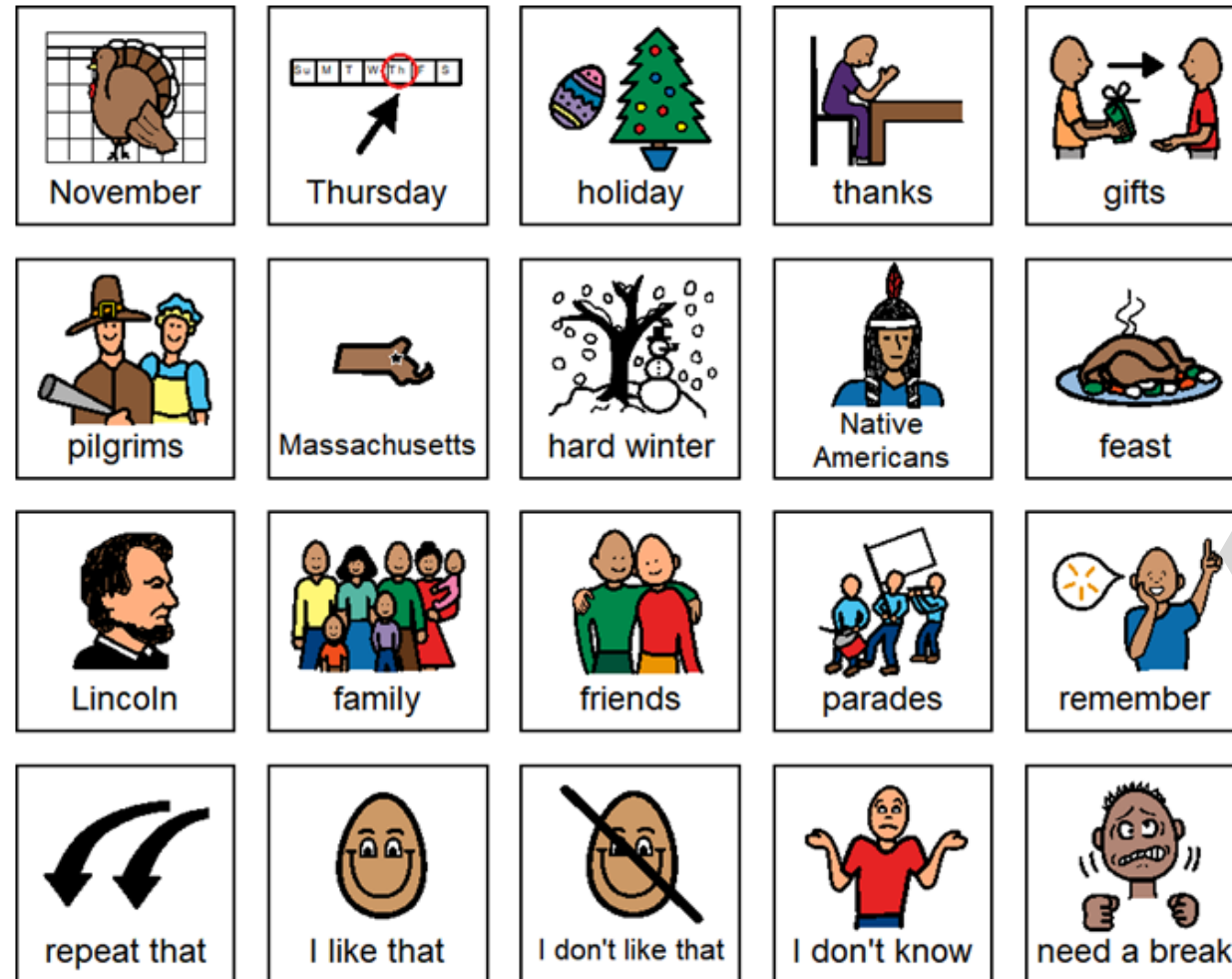

Place the things you about Thanksgiving in the circle map.



Choose from the pictures below to finish the sentences on the previous page.









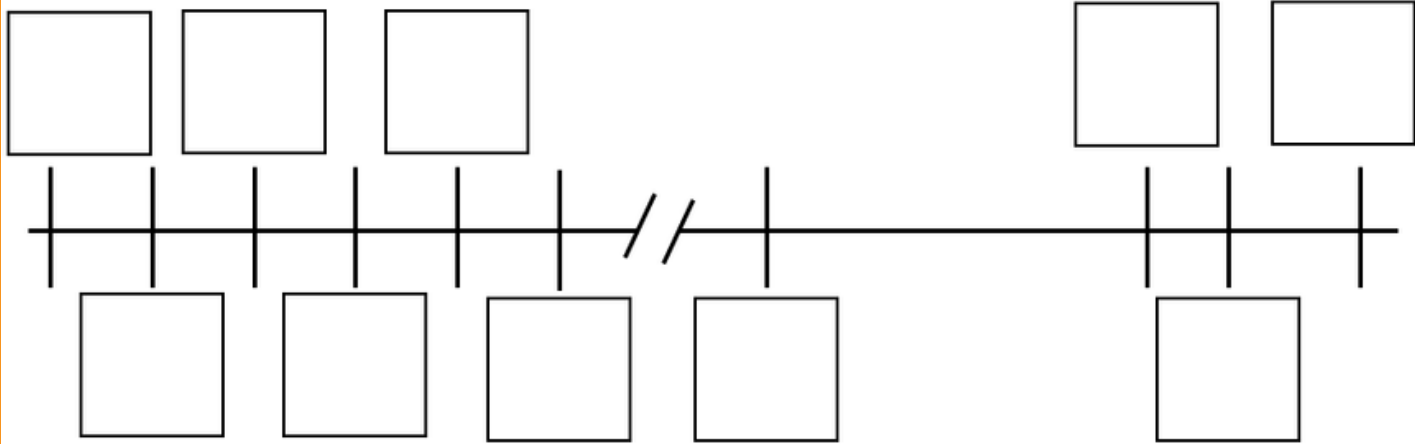



There is a circle map showing Thanksgiving things from the book. There is an option that only has correct answers and one that has wrong answers mixed in.



Thanksgiving Timeline

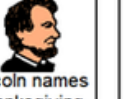

- | | | | | |
|--|--|---|---|--|
| 
Egyptians praised Min | 
parades | 
Greeks thank Demeter | 
Middle Age festivals | 
Jewish celebrate Sukkot |
| 
pilgrims | 
Romans thank Ceres | 
China honored moon | 
Lincoln names Thanksgiving Day | 
Roosevelt changes day |

Thanksgiving Timeline

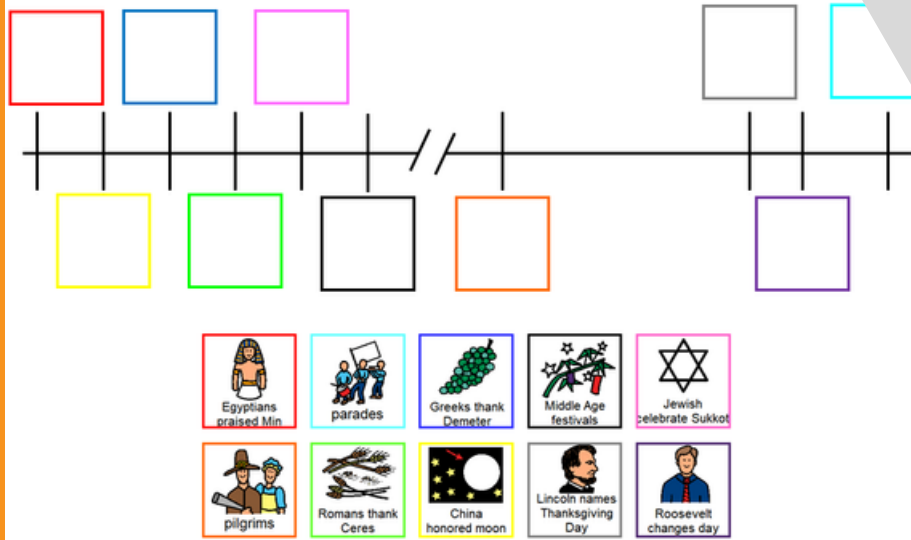

There is a timeline of things mentioned in the book. There is a color-coded option provided for students who need more support.

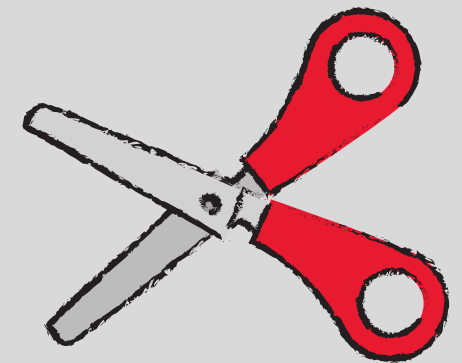

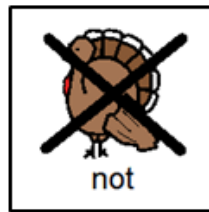

 turkey dinner	 valentine	 Native Americans	 give thanks
 gingerbread house	 cranberry sauce	 yams	 holly
 fireworks	 football	 stocking	 turkey
 pumpkin pie	 pilgrims	 Easter egg	 witch

Students will sort things that are and are not Thanksgiving related. Suggestions for differentiation are included.

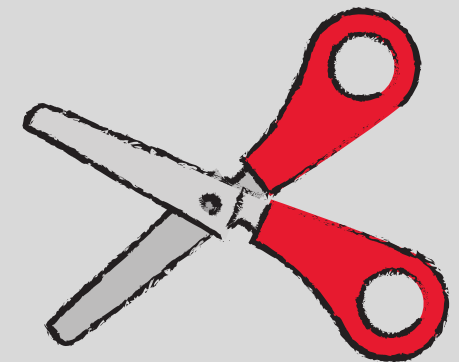

Write the days in the boxes to go with the current year.
Place the turkey on Thanksgiving Day.



Sunday	Monday	Tuesday	Wednesday	Thursday	Friday	Saturday
<input type="checkbox"/>	<input type="checkbox"/>	<input type="checkbox"/>	<input type="checkbox"/>	<input type="checkbox"/>	<input type="checkbox"/>	<input type="checkbox"/>
<input type="checkbox"/>	<input type="checkbox"/>	<input type="checkbox"/>	<input type="checkbox"/>	<input type="checkbox"/>	<input type="checkbox"/>	<input type="checkbox"/>
<input type="checkbox"/>	<input type="checkbox"/>	<input type="checkbox"/>	<input type="checkbox"/>	<input type="checkbox"/>	<input type="checkbox"/>	<input type="checkbox"/>
<input type="checkbox"/>	<input type="checkbox"/>	<input type="checkbox"/>	<input type="checkbox"/>	<input type="checkbox"/>	<input type="checkbox"/>	<input type="checkbox"/>
<input type="checkbox"/>	<input type="checkbox"/>	<input type="checkbox"/>	<input type="checkbox"/>	<input type="checkbox"/>	<input type="checkbox"/>	<input type="checkbox"/>

Students will fill out a calendar for the month of November and label Thanksgiving Day.

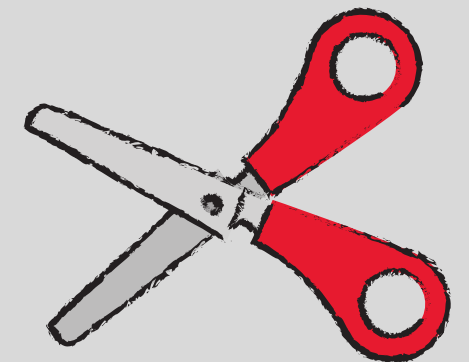



Thanksgiving is

Thanksgiving is

Thanksgiving is

Thanksgiving is

Thanksgiving is

Christa Joy, Special Needs for Special Kids The Picture Communication Symbols ©1981–2019 by Tobii Dynavox. All Rights Reserved Worldwide. Used with permission. Boardmaker® is a trademark of Tobii Dynavox

Choose from the pictures below to finish the sentences on the previous page.

 turkey dinner	 history	 Native Americans	 give thanks	 dessert
 family	 cranberry sauce	 yams	 friends	 November
 Thursday	 football	 parades	 turkey	 remembering
 pumpkin pie	 pilgrims	 pumpkin	 stuffing	 corn

Christa Joy, Special Needs for Special Kids The Picture Communication Symbols ©1981–2019 by Tobii Dynavox. All Rights Reserved Worldwide. Used with permission. Boardmaker® is a trademark of Tobii Dynavox

There is a writing prompt. Students will write a story about what Thanksgiving is for them. This is an errorless activity.

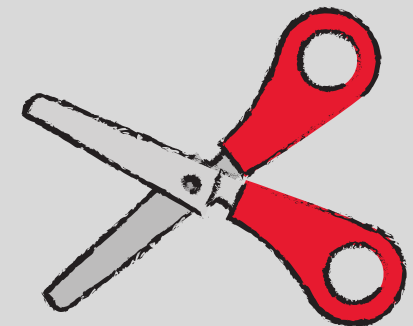

Listen to the
book read
aloud





















There is a video of the book
read aloud from YouTube in
case you cannot find a copy
of the book.

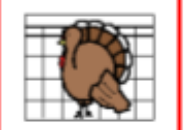

Make great independent learning centers

Choose a word to finish each sentence.

Thanksgiving is	<input type="text"/>	 turkey dinner	 history	 give thanks	 pilgrims	 Native Americans
Thanksgiving is	<input type="text"/>	 family	 parades	 time to remember	 games	 football
Thanksgiving is	<input type="text"/>	 desserts	 turkey dinner	 cranberry sauce	 yams	 turkey
Thanksgiving is	<input type="text"/>	 November	 Thursday	 pumpkin	 stuffing	 corn
Thanksgiving is	<input type="text"/>					

There are digital versions of the activities included. Students click and drag the answers.

Perfect for every learning level

There are 2 sets, one that includes differentiation shown here.



Sort the pictures related to Thanksgiving. If you are not sure, leave it on this side.

 turkey dinner	 valentine	 Native Americans	 give thanks
 gingerbread house	 cranberry sauce	 yams	
 fireworks	 football	 stocking	 turkey
 pumpkin pie	 pilgrims	 Easter egg	 witch

Christa Joy, Special Needs for Special Kids
The Picture Communication Symbols ©1981–2019 by Tobii Dynavox. All Rights Reserved
Worldwide. Used with permission. Boardmaker® is a trademark of Tobii Dynavox